



浙江宝龙机电有限公司

Zhejiang Baolong M&E Co.,Ltd.

承认书

APPROVAL SHEET

版本号: A0

客户信息	客户名称 Customer	
	客户代码 Customer Code	
	项目名称 Project Name	
	料号 Part Number	
	客户承认签章 Customer Approval & Signatures	

宝龙机电	产品名称 Product Name	扁平振动马达 Coin vibration motor				
	产品型号 Product Model	BVM0625H-FP202-U				
	设计 Design	钱浩 Qianhao	审核 Check	刘勇强 Liu YongQiang	批准 Approval	兰德福 Lan Defu

地址:中国浙江省乐清市宁康东路 388 号

ADD:No.388, Ningkang East Road, Yueqing City, Zhejiang Province, China

邮政编码/POST CODE: 325600

电话/PHONE: 0577-62578888

传真/FAX: 0577-62574808

邮箱/E-mail: BLJSB@BAOLONG.COM

产品规格书/Specifications	日期/Date :2021-9-13	
振动电机/Vibration motor:BVM0625H-FP202-U	页码/Page: 2 / 14	版本/Version:A0

- 目录/List -

封面/Cover	1/14
目录/Contents	2/14
更改记录/Revision History	3/14
1.适用范围/Scope of Application	4/14
2.使用条件/Standard operating condition	4/14
3.测试条件/Testing condition	5/14
4.电气特性/Electrical characteristics	5/14
5.机械特性/Mechanical characteristics	6/14
6.环境试验/Environmental test	7、8/14
7.寿命试验/Life test	9/14
8.注意事项/Caution	10/14
9.附/Attached	11/14
9-1 马达特性图/characteristic graph of motor	
9-2 标准测量方式/state of standard measurement	
10.外形图/Outside view	12/14
11.结构图及物料清单/Structure drawing & BOM	13/14
12.包装/Packaging	14/14

产品规格书/Specifications	日期/Date :2021-9-13	
振动电机/Vibration motor:BVM0625H-FP202-U	页码/Page: 4 / 14	版本/Version:A0

1.适用范围/Scope of application

本规格书适用于浙江宝龙机电有限公司制造的应用于移动电话的振动电机。

This specification sheet is stipulated for vibration motor, which is manufactured by Zhejiang Baolong M&E Co., Ltd.for mobile phone.

型号名称标准/Standard of model name:

BVM 0625 H

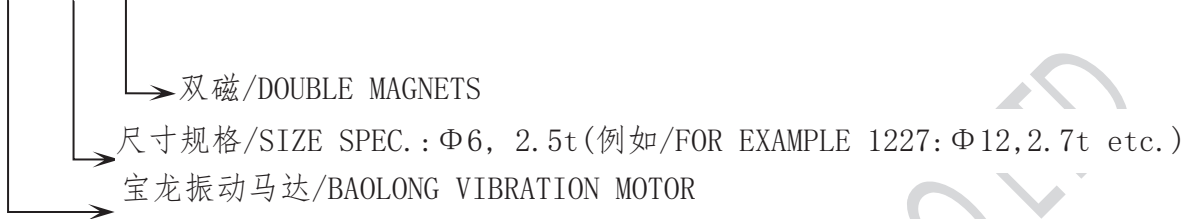

2.使用条件/Standard operating condition

NO.	项目/Item	规格/Specifications
2-1	额定电压 Rated voltage	DC2.5V
2-2	使用电压范围 Operating voltage range	DC 2.0~3.5V
2-3	旋转方向 Rotating direction	CW / CCW
2-4	使用温度范围 Operating temperature range	-30℃~+70℃
2-5	保存环境范围 Storage temperature range	-40℃~+80℃

产品规格书/Specifications	日期/Date :2021-9-13	
振动电机/Vibration motor:BVM0625H-FP202-U	页码/Page: 5 / 14	版本/Version:A0

3.测试条件/Testing condition

NO.	项目/Item	规格/Specifications
3-1	温度 Temperature	25°C±3
3-2	湿度 Humidity	45% ~85%RH
3-3	电源电压 Power supply, voltage source	直流电源或电池 2.5V DC power supply or battery 2.5V
3-4	马达安放状态 Posture of motor	标准测量方式 State of standard measurement

4.电气特性/Electrical characteristic

NO.	项目/Item	单位/Unit	规格/SPEC.	条件/Condition
4-1	额定转速 Rated speed	rpm	10000Min	额定电压:DC 2.5V Rated voltage:DC 2.5V
4-2	额定电流 Rated current	mA	100Max	额定电压:DC 2.5V Rated voltage:DC 2.5V
4-3	启动电压 Starting voltage	V	2.0Max	DC2.0V电压下, 开/关为1个循环, 共3个循环 On/off-1cycle,total 3cycles under DC2.0V
4-4	端子阻抗 Terminal resistance	Ω	相接触/ Phase contact: 23±20% 相串联/ Phase senrial: 45±20% 相并联/ Phase parallel: 12±20%	正极和负极之间 Between positive and negative
4-5	启动电流 Starting current	mA	150Max	启动电压:DC 2.0Max Starting voltage:DC 2.0Max
4-6	绝缘电阻 Insulationresistance	MΩ	10Min	测量机壳和引线之间。 测试电压直流100V。 Measuring between case and lead wire. Test voltage DC 100V

产品规格书/Specifications	日期/Date :2021-9-13	
振动电机/Vibration motor:BVM0625H-FP202-U	页码/Page: 6 / 14	版本/Version:A0

5.机械特性/Mechanical characteristics

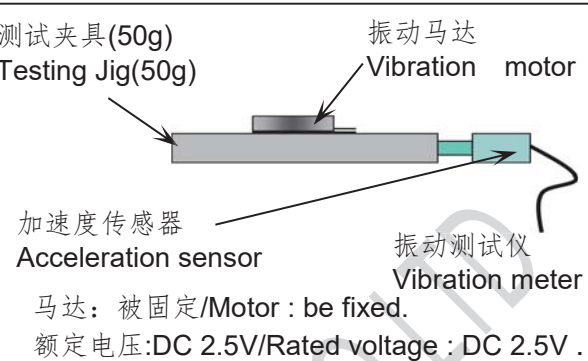
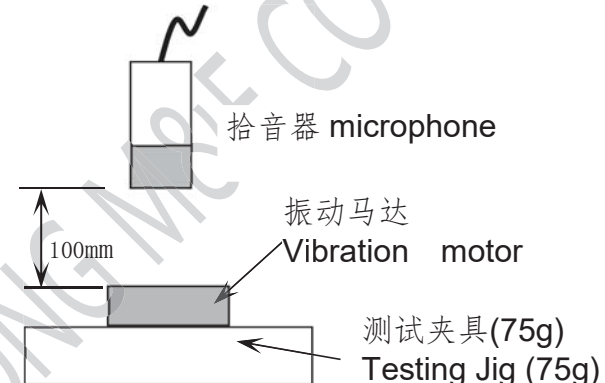
NO	项目/Item	单位/Unit	规格/SPEC	条件/Condition
5-1	振动量 Vibration Strength	Grms	0.3 Min	 <p>测试夹具(50g) Testing Jig(50g)</p> <p>振动马达 Vibration motor</p> <p>加速度传感器 Acceleration sensor</p> <p>振动测试仪 Vibration meter</p> <p>马达: 被固定/Motor : be fixed. 额定电压:DC 2.5V/Rated voltage : DC 2.5V .</p>
		Gp	0.5 Min	
5-2	机械噪音 Mechanical Noise	dB	50 Max	 <p>拾音器 microphone</p> <p>100mm</p> <p>振动马达 Vibration motor</p> <p>测试夹具(75g) Testing Jig (75g)</p> <p>马达: 被固定/Motor : be fixed 额定电压:DC 2.5V/Rated voltage : DC 2.5 V 背景噪音: 25dB MAX. Back ground noise: 25dB MAX. 拾音器沿轴向正对电机平面 Microphone faces the plane of motor along the shaft</p>
5-3	底盖偏转强度 Bracket Deflection Strength	gf	1000 Min	通过推拉计进行破坏测试 Demolition test by push-pull gauge.

产品规格书/Specifications	日期/Date :2021-9-13	
振动电机/Vibration motor:BVM0625H-FP202-U	页码/Page: 7 / 14	版本/Version:A0

6.环境试验/Environmental test

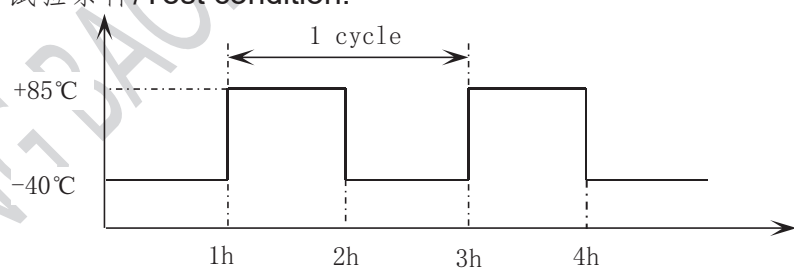
NO	项目/Item	条件/Condition
6-1	低温贮存试验 Low temperature Storage test	在-40℃的环境下放置96小时，然后在常温常湿下恢复2小时后测试。 Exposed at -40℃ for 96hours, then return to normal temperature and humidity for 2 hours before test.
6-2	高温贮存试验 High temperature Storage test	在+80℃的环境下放置96小时，然后在常温常湿下恢复2小时后测试。 Exposed at +80℃ for 96hours, then return to normal temperature and humidity for 2 hours before test.
6-3	高湿贮存试验 High humidity Storage test	在+40℃,90%RH的环境下放置96小时，然后在常温常湿下恢复2h后测试。 Exposed at +40℃ 90%RH for 96hours, then return to normal temperature and humidity for 2 hours before test.
6-4	温冲试验 Thermal shock test	<p>马达按照以下试验条件放置 15 个周期，然后在常温常湿下放置 2 小时后测试。 Confirmed to operating of motor during 15 cycles as following test condition, then return to normal temperature and humidity for 2 hours before test.</p> <p>试验条件/Test condition:</p>  <p>高低温转换时间：≤5分钟 Transfer time between high temperature and low temperature:≤5min</p>
6-5	跌落 Drop test	将马达固定在100g的塑料夹具上，从1.5米的高度跌落到水泥地面上，六个面的每个面都跌落2次。 The motor that is attached to a 100g jig (plastic housing) and drop it onto the concrete floor from 1.5m height. Drop twice in each of the six planes.

产品规格书/Specifications	日期/Date :2021-9-13	
振动电机/Vibration motor:BVM0625H-FP202-U	页码/Page: 8 / 14	版本/Version:A0

6-6	振动试验 Vibration test	<p>将马达固定在100g的塑料夹具上，按以下要求进行试验：</p> <p>1)振频范围:10-55Hz 2)全振幅1.5mm 3)振频变化10-55-10 约10分钟 4)振动方向:三个垂直方向 5)持续时间:每个方向10分钟（共30分钟）</p> <p>The motor that is attached to a 100g jig (plastic housing) and test according following condition:</p> <p>1)Vibration frequency range: 10~55Hz 2)Total amplitude: 1.5mm 3)Sweep ratio: 10~55~10Hz approximate 10min 4)Direction of vibration: Three perpendicular directions 5)Duration: 10min(30min in total)</p>
-----	------------------------	---

▶ 判定标准/Judgment standard

① 试验后，测试数据必须符合以下规格：

After test, measured data must be satisfied as following specifications;

- 启动电压: DC2.0V MAX.
- Starting voltage: DC2.0V MAX.
- 额定转速: 变化率在初始值的-30%~+50%以内。
- Rated speed: changing rate must be within -30%~+50% of initial value.
- 额定电流: 变化率在初始值的-30%~+50%以内。
- Rated current: changing rate must be within -30%~+50% of initial value.
- 端子阻抗: 变化率在初始值的±15%以内。
- Terminal resistance: changing rate must be within ±15% of initial value.

② 外形结构无异常。

There should be no abnormalities in appearance and structure.

产品规格书/Specifications	日期/Date :2021-9-13	
振动电机/Vibration motor:BVM0625H-FP202-U	页码/Page: 9 / 14	版本/Version:A0

7.寿命试验/Life test

▶ 试验条件/Test condition:

1 秒转, 1 秒停为 1 个周期, 共 5 万次。

(DC2.5V, 常温常湿)

1 SEC ON, 1SEC OFF 1CYCLE , 50,000 CYCLES.

(DC2.5V, at normal temperature and humidity)

▶ 试验条件 2/Test condition2:

0.5 秒转, 0.5 秒停为 1 个周期, 共 5 万次。

(DC2.5V, 常温常湿)

0.5 SEC ON, 0.5SEC OFF 1CYCLE , 50,000 CYCLES.

(DC2.5V, at normal temperature and humidity)

▶ 判定条件/Judgment standard:

试验后, 测试数据必须符合以下规格:

After test, measured data must be satisfied as following specifications;

- 启动电压: DC2.0V MAX.
- Starting voltage: DC2.0V MAX.
- 额定转速: 变化率在初始值的-30%~+50%以内。
- Rated speed: changing rate must be within -30%~+50% of initial value.
- 额定电流: 变化率在初始值的-30%~+50%以内。
- Rated current: changing rate must be within -30%~+50%of initial value.

产品规格书/Specifications	日期/Date :2021-9-13
振动电机/Vibration motor:BVM0625H-FP202-U	页码/Page: 10 / 14 版本/Version:A0

8.注意事项/CAUTION FOR USE

(1) 该马达是微型精密产品，在运输过程中不要承受超过0.5 kgf的力，否则会引起外形或性能的变化。

As this motor is small and precise, do not press it over 0.5kgf force or while transportation, it can cause the transformation of performance or external appearance.

(2) 请注意马达不要接触到液体性物质（比如：水，酒精等）

please be careful, not to be contacted fluid substances (such as: water, alcohol etc.)

(3) 不要在高温下长时间放置，否则有可能导致电机的性能下降。

Do not expose the motor to high temperature for a long periods of time, it may cause a decline in performance.

(4) 马达不要在以下环境中使用：

- 高温和高湿的场所
- 腐蚀性气体如H₂S、SO₂、NO₂等
- Avoid using the motor in the following environment.
- High temperature and high humidity area.
- Corrosive gas such as H₂S、SO₂、NO₂ etc.

(5) 请不要在靠近磁铁或带有磁场的仪器旁边使用或存放马达。

Please do not operate or store the motor adjacent to magnet or apparatus That has a magnetic field.

(6) 请注意底盖的表面存在漏磁通量。

Please be careful that there exists a leaking magnetic flux on the surface of bracket.

(7) 电刷和换向器的相互作用，有可能产生轻微的电噪音。

Due to interaction between brush and commutator, there is a possibility to occur electrical noise slightly.

(8) 如有任何问题，宝龙和客户双方应共同努力解决。

If any problems occur, both the user and baolong electron shall try to solve the problem.

(9) 因测试设备有误差，允许有±5%偏差。

Because there is error of the measurement equipment ,permit the standard of the rotational frequency to ±5%

(10) 马达通过ROHS(欧盟指令 2015/863/EU, 2011/65/EU.)认证

This motor pass the system of ROHS (directive 2015/863/EU and 2011/65/EU) certification

9. 附/Attached

9-1 马达特性图/characteristic graph of motor

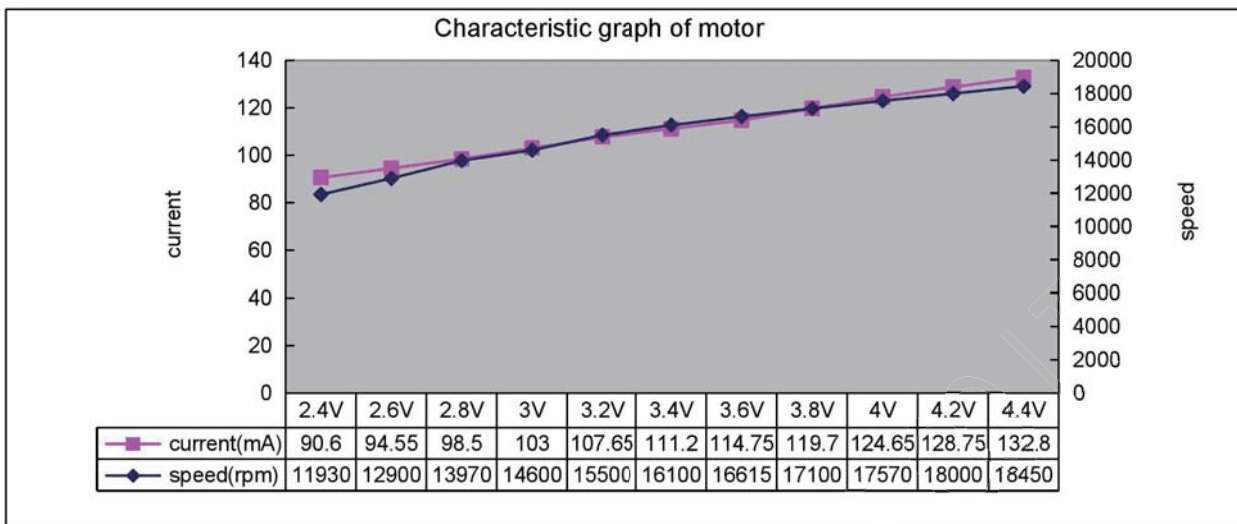

9-2 标准测量方式/state of standard measurement

测试项目：启动电压，额定电压下的电流，额定电压下的转速，绝缘电阻。

Measure item: starting voltage, current at rated voltage, speed at rated voltage, insulation resistance.

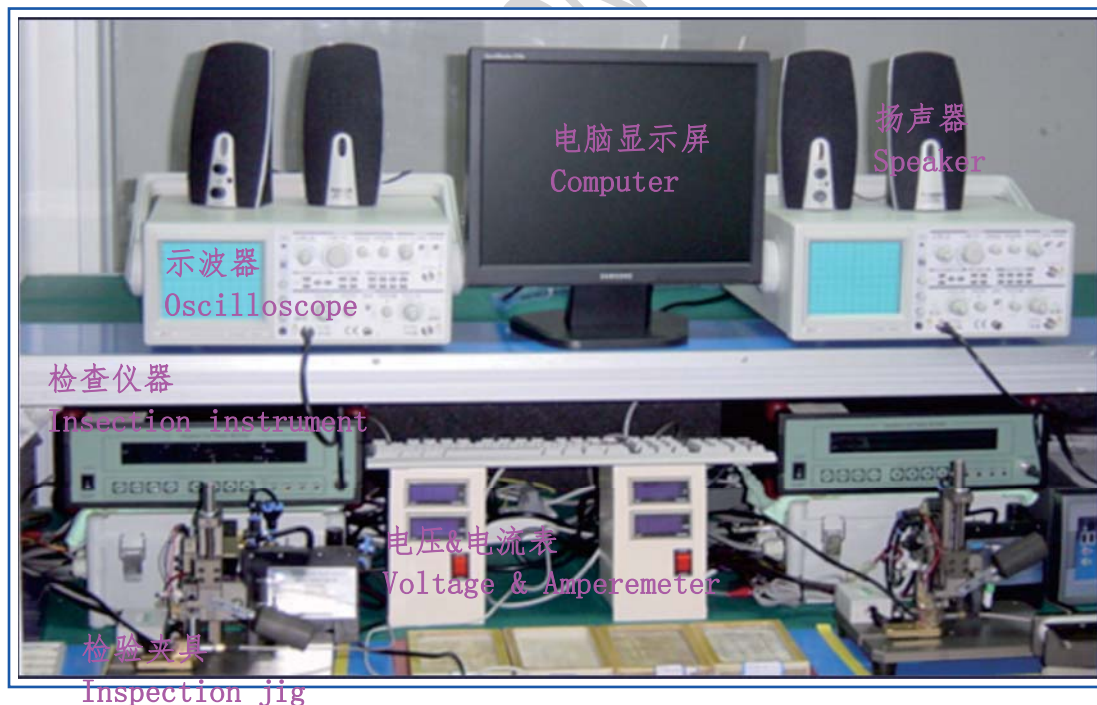

10. 外形图/Outside view

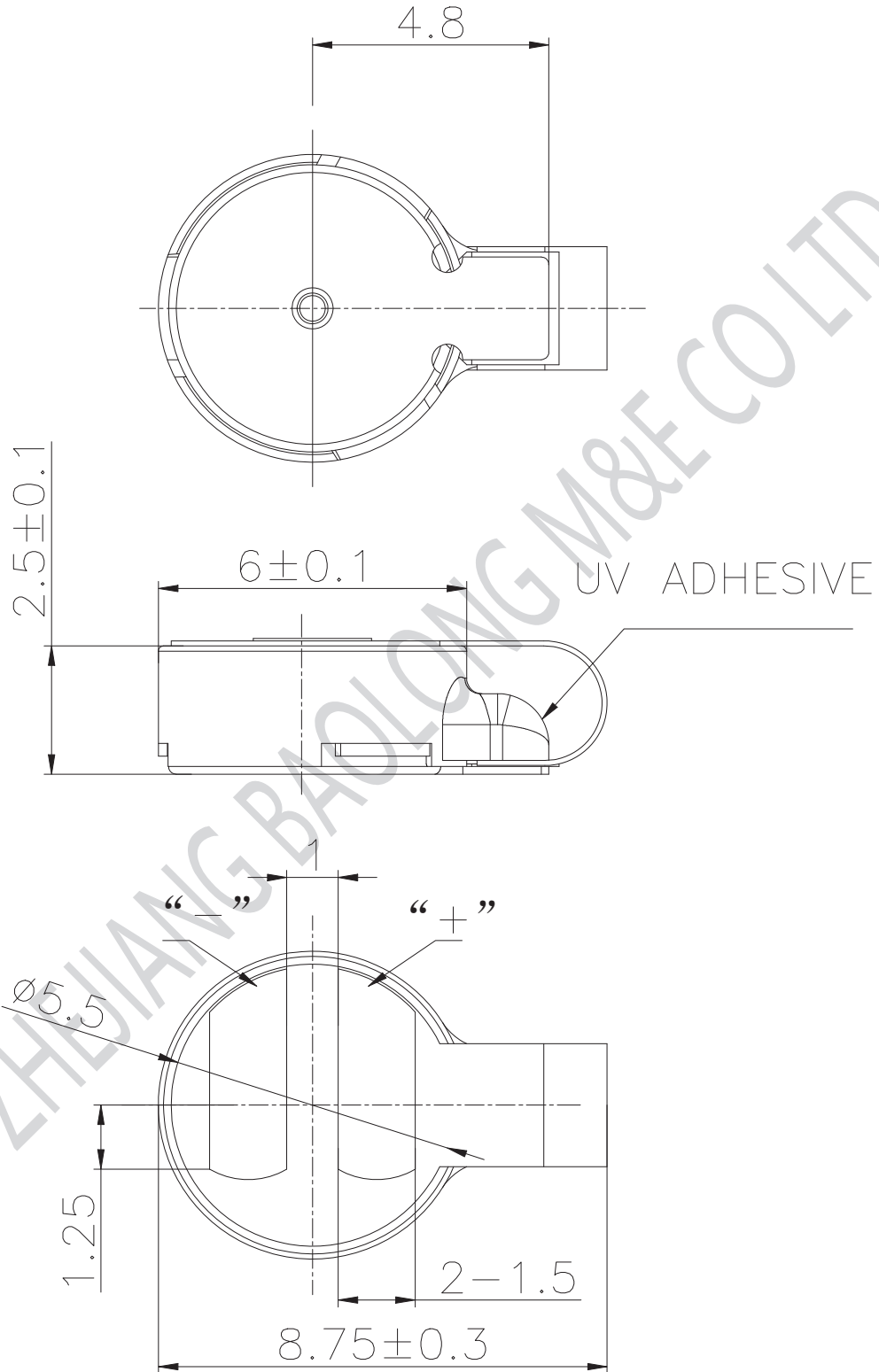

11. 结构图及物料清单/Structure drawing & BOM

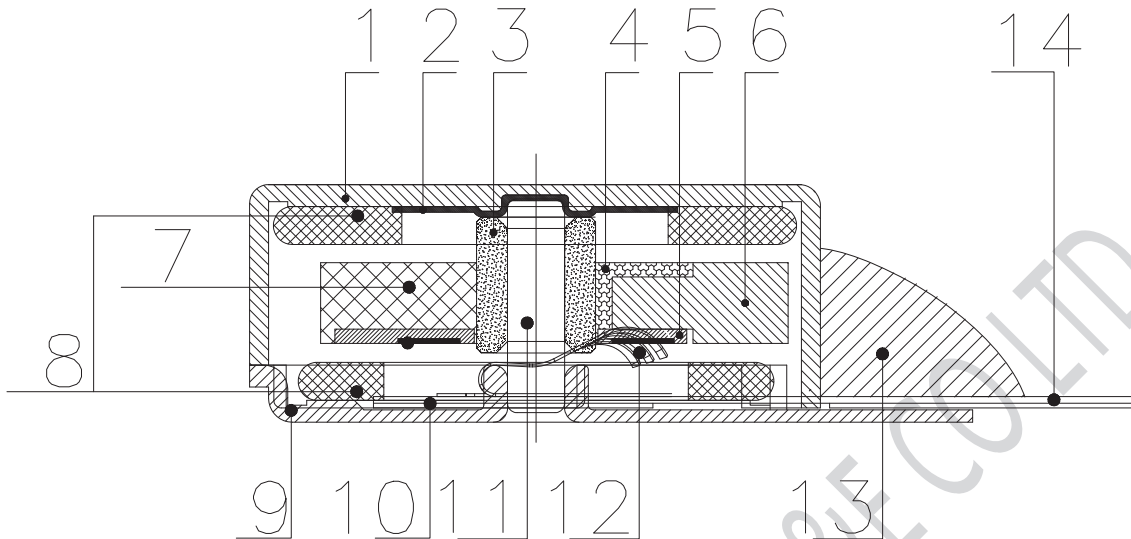

NO.	物料名称/Part name	材料/Material
1	上机壳 Upper case	SPC-E
2	滑片 Slide	PE+ACRYLIC
3	轴承 Bearing	Cu+Fe
4	线圈 Coil	Copper+PU
5	硬基板 HPCB	EPOXY
6	振子 Weight	Tungsten alloy
7	塑料 Resin	PBT
8	磁钢 Magnet	NdFeB
9	下机壳 Lower case	SPC-E
10	软基板 FPCB	PI+AD+Copper+Glue
11	钢轴 Shaft	DSR7B
12	电刷 Brush	MX215
13	UV 胶水 UV adhesive	Acryloid cement
14	软基板 FPCB	PI+AD+Copper+Glue

产品规格书/Specifications	日期/Date :2021-9-13	
振动电机/Vibration motor:BVM0625H-FP202-U	页码/Page: 14 / 14	版本/Version:A0

12. 包装/Packaging



吸塑盒尺寸(长:250mm 宽:210mm 高:11mm)
 Tray dimension (L:250mm W:210mm H:11mm)
 每个吸塑盒放 100 只
 100 Pcs per tray



内箱尺寸(260mm 宽:215mm 高:80mm)
 Inner-box dimension (L:260mm W:215mm
 H:80mm)
 每 11 个吸塑盒捆在一起,数量为 1000 只,装
 入内箱
 Put into inner-box 11 tray together
 with tape 1000 Pcs per 11 tray .



4 个内箱装入外箱, 数量共 4000 只;
 Put 4 inner-box into outer-box, total
 4000 Pcs.
 外箱尺寸: (450mm 宽:280mm 高:180mm)
 Outer-box dimension:
 (L:450mm W:280mm H:180mm)