



浙江宝龙机电有限公司

ZHEJIANG BAOLONG M&E CO., LTD.

承认书

APPROVAL SHEET

| | | |
|------|---|--|
| 客户信息 | 客户 Customer | |
| | 客户代码 Customer code | |
| | 项目名称 Project | |
| | 料号 Part No. | |
| | 客户承认签章 Customer's Approval & Signatures | |

| | | | | | | |
|------|--------------------|----------------------------------|------------|--------------|-------------|-----------|
| 宝龙公司 | 产品名称 Product Name | 扁平振动马达 Flat type vibration motor | | | | |
| | 产品型号 Product Model | BVM0720-FP35-1RU | | | | |
| | 设计 Design | 麻鲁兵 Ma Lubing | 审核 Checked | 兰德福 Lan Defu | 批准 Approved | 李军 Li Jun |

地址: 中国浙江省乐清市宁康东路宝龙工业园

ADD: NINGKANG EAST RD. BAOLONG INDUSTRIAL REGION,

YUEQING, ZHEJIANG PROVINCE, CHINA

邮政编码/POST CODE: 325600

电话/PHONE: 0577-62578888

传真/FAX: 0577-62574808

网址/WEB: [HTTP://WWW.BAOLONG.COM](http://www.baolong.com)

邮箱/E-mail: BL@BAOLONG.COM

| | |
|---------------------------------------|-------------------|
| 产品规格书/Specifications | 日期/Date :2016-9-8 |
| 振动马达/Vibration motor:BVM0720-FP35-1RU | 页码/Page : 1 / 13 |

- 内容/CONTENTS -

| | |
|--|-----------|
| 1. 规格书内容/CONTENTS | 1/13 |
| 2. 文件版本/File colophon | 2/13 |
| 3. 适用范围/Scope of application | 3/13 |
| 2. 使用条件/Standard operating condition | 3/13 |
| 3. 测试条件/Testing condition | 4/13 |
| 4. 电气特性/Electrical characteristics | 4/13 |
| 5. 机械特性/Mechanical characteristics | 5/13 |
| 6. 环境试验/Environmental test | 6/13~7/13 |
| 7. 寿命试验/Life test | 8/13 |
| 8. 注意事项/Caution | 9/13 |
| 9. 附/Attached | 10/13 |
| 9-1 马达特性图/characteristic graph of motor | |
| 9-2 标准测量方式/state of standard measurement | |
| 10. 外形图/Outside view | 11/13 |
| 11. 结构图及物料清单/Structure drawing & BOM | 12/13 |
| 12. 包装/Packaging | 13/13 |

文件版本/File colophon

| 版本 Issue | 编制 originator | 批准 approval | 更改详情 Detail spec changes | 日期 Date |
|-------------|------------------|----------------|-----------------------------|------------|
| Ver1 | | | 初始规格/Preliminary spec | 2016-9-8 |
| Ver2 | | | | |
| Ver3 | | | | |
| Ver4 | | | | |
| Ver5 | | | | |
| Ver6 | | | | |
| Ver7 | | | | |
| Ver8 | | | | |
| Ver9 | | | | |
| Ver10 | | | | |

1. 适用范围/Scope of application

| | |
|---------------------------------------|-------------------|
| 产品规格书/Specifications | 日期/Date :2016-9-8 |
| 振动马达/Vibration motor:BVM0720-FP35-1RU | 页码/Page : 3 / 13 |

本规格书适用于宝龙电子集团有限公司制造的应用于移动电话的振动马达。
This specification sheet is stipulated for vibration motor, which is manufactured by baolong electron co., Ltd. for mobile phone.

型号名称标准/Standard of model name:
BVM 0720

尺寸规格/SIZE SPEC.: $\Phi 7$, 2.0t (例如/FOR EXAMPLE 1227: $\Phi 12$, 2.7t etc.)
→ 宝龙振动马达/BAOLONG VIBRATION MOTOR

2. 使用条件/Standard operating condition

| NO. | 项目/Item | 规格/Specifications |
|-----|---------------------------------------|-------------------|
| 2-1 | 额定电压 Rated voltage | DC3.0V |
| 2-2 | 使用电压范围 Operating voltage range | DC 2.5~3.3V |
| 2-3 | 旋转方向 Rotating direction | CW / CCW |
| 2-4 | 使用温度范围 Operating temperature range | -30°C ~ +70°C |
| 2-5 | 保存环境范围 Storage temperature range | -40°C ~ +80°C |

| | |
|---------------------------------------|-------------------|
| 产品规格书/Specifications | 日期/Date :2016-9-8 |
| 振动马达/Vibration motor:BVM0720-FP35-1RU | 页码/Page : 4 / 13 |

3. 测试条件/Testing condition

| NO. | 项目/Item | 规格/Specifications |
|-----|--------------------------------------|---|
| 3-1 | 温度 Temperature | 25°C ±3 |
| 3-2 | 湿度 Humidity | 45% ~85%RH |
| 3-3 | 电源电压 Power supply, voltage source | 直流电源或电池 3.0V DC power supply or battery 3.0V |
| 3-4 | 马达安放状态 Posture of motor | 标准测量方式 State of standard measurement |

4. 电气特性/Electrical characteristic

| NO. | 项目/Item | 单位 /Unit | 规格/SPEC. | 条件/Condition |
|-----|-------------------------------|-------------|--|---|
| 4-1 | 额定转速 Rated speed | rpm | 8000 Min | 额定电压:DC 3.0V Rated voltage:DC 3.0V |
| 4-2 | 额定电流 Rated current | mA | 85 Max | 额定电压:DC 3.0V Rated voltage:DC 3.0V |
| 4-3 | 启动电压 Starting voltage | V | 2.5 Max | DC2.5V电压下, 开/关为1个循环, 共3个循环 On/off-1cycle, total 3cycles under DC2.5V |
| 4-4 | 端子阻抗 Terminal resistance | Ω | 单相 1phase: 50 ± 20% 双相 2phase: 90 ± 20% | 正极和负极之间 Between positive and negative |
| 4-5 | 启动电流 Starting current | mA | 120Max | 启动电压:DC 2.5Max Starting voltage:DC 2.5Max |
| 4-6 | 绝缘电阻 Insulation resistance | MΩ | 10Min | 测量机壳和引线之间。 测试电压直流100V。 Measuring between case and lead wire. Test voltage DC 100V |

5. 机械特性/Mechanical characteristics

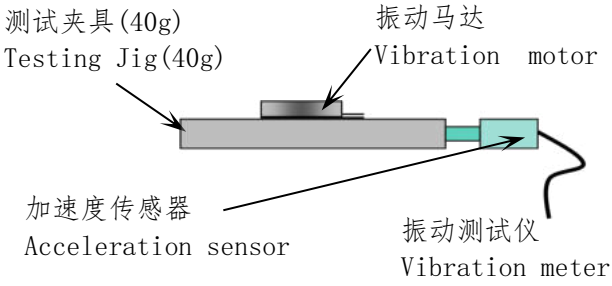
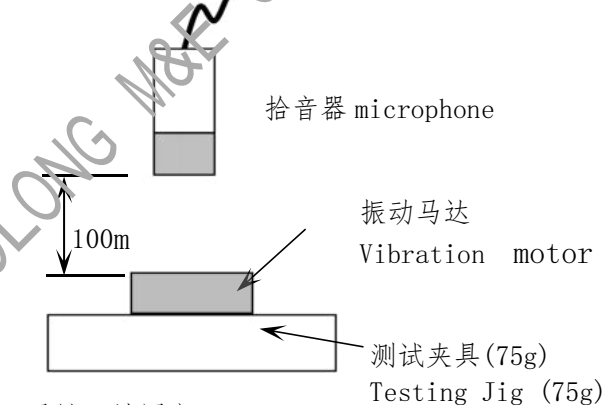
| NO | 项目/Item | 单位/Unit | 规格/SPEC. | 条件/Condition |
|-----|------------------------------------|---------|----------|---|
| 5-1 | 振动量 Vibration Strength | G | 0.2 MIN |  <p>测试夹具(40g) Testing Jig(40g)</p> <p>振动马达 Vibration motor</p> <p>加速度传感器 Acceleration sensor</p> <p>振动测试仪 Vibration meter</p> <p>马达: 被固定/Motor : be fixed. 额定电压:DC 3.0V/Rated voltage : DC 3.0V .</p> |
| 5-2 | 机械噪音 Mechanical Noise | dB | 50 MAX |  <p>拾音器 microphone</p> <p>100m</p> <p>振动马达 Vibration motor</p> <p>测试夹具(75g) Testing Jig (75g)</p> <p>马达: 被固定。 Motor : be fixed 额定电压:DC 3.0V Rated voltage : DC 3.0 V 背景噪音: 25dB MAX. Back ground noise: 25dB MAX. 拾音器沿轴向正对电机平面 Microphone faces the plane of motor along the shaft</p> |
| 5-3 | 底盖偏转强度 Bracket Deflection Strength | gf | 1000 MIN | 通过推拉计进行破坏测试 Demolition test by push-pull gauge. |

| | |
|---------------------------------------|-------------------|
| 产品规格书/Specifications | 日期/Date :2016-9-8 |
| 振动马达/Vibration motor:BVM0720-FP35-1RU | 页码/Page : 6 / 13 |

6. 环境试验/Environmental test

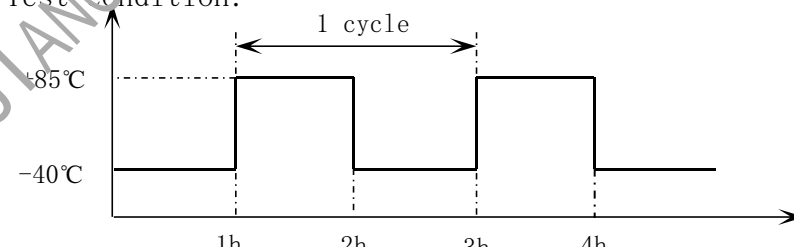
| NO | 项目/Item | 条件/Condition |
|-----|---|---|
| 6-1 | 低温贮存试验 Low temperature Storage test | 在-40℃的环境下放置96小时，然后在常温常湿下恢复2小时后测试。 Exposed at -40℃ for 96hours, then return to normal temperature and humidity for 2 hours before test. |
| 6-2 | 高温贮存试验 High temperature Storage test | 在+80℃的环境下放置96小时，然后在常温常湿下恢复2小时后测试。 Exposed at +80℃ for 96hours, then return to normal temperature and humidity for 2 hours before test. |
| 6-3 | 高湿贮存试验 High humidity Storage test | 在+40℃,90%RH的环境下放置96小时，然后在常温常湿下恢复2h后测试。 Exposed at +40℃ 90%RH for 96hours, then return to normal temperature and humidity for 2 hours before test. |
| 6-4 | 温冲试验 Thermal shock test | <p>马达按照以下试验条件放置15个周期，然后在常温常湿下放置2小时后测试。 Confirmed to operating of motor during 15 cycles as following test condition, then return to normal temperature and humidity for 2 hours before test.</p> <p>试验条件: Test condition:</p>  <p>高低温转换时间: ≤5分钟 Transfer time between high temperature and low temperature: ≤5min</p> |
| 6-5 | 跌落 Drop test | 马达从1.2米的高度跌落到水泥地面上，跌落12次。 The motor drop to a concrete floor from 1.2m in height. Drop twelve times. |

| | | |
|-----|--|--|
| 6-6 | <p style="text-align: center;">振动试验 Vibration test</p> | <p>将马达固定在100g的塑料夹具上，按以下要求进行试验：</p> <p>1) 振频范围:10-55Hz 2) 全振幅1.5mm 3) 振频变化10-55-10 约10分钟 4) 振动方向:三个垂直方向 5) 持续时间:每个方向10分钟（共30分钟）</p> <p>The motor that is attached to a 100g jig (plastic housing) and test according following condition:</p> <p>1)Vibration frequency range: 10~55Hz 2)Total amplitude: 1.5mm 3)Sweep ratio: 10~55~10Hz approximate 10min 4)Direction of vibration: Three perpendicular directions 5)Duration: 10min(30min in total)</p> |
|-----|--|--|

► 判定标准/Judgment standard

① 试验后，测试数据必须符合以下规格：

After test, measured data must be satisfied as following specifications;

- 启动电压: DC2.5V MAX.
- Starting voltage: DC2.5V MAX.
- 额定转速: 变化率在初始值的-30%~+50%以内。
- Rated speed: changing rate must be within -30%~+50% of initial value.
- 额定电流: 变化率在初始值的-30%~+50%以内。
- Rated current: changing rate must be within -30%~+50% of initial value.
- 端子阻抗: 变化率在初始值的±15%以内。
- Terminal resistance: changing rate must be within ±15% of initial value.

② 外形结构无异常.

There should be no abnormalities in appearance and structure.

7. 寿命试验/Life test

▶试验条件/Test condition:

1 秒转, 1 秒停为 1 个周期, 共 10 万次。

(DC3.0V, 常温常湿)

1 SEC ON, 1SEC OFF 1CYCLE , 100,000 CYCLES.

(DC3.0V, at normal temperature and humidity)

▶判定条件/Judgment standard:

试验后, 测试数据必须符合以下规格:

After test, measured data must be satisfied as following specifications:

- 启动电压: DC2.5V MAX.
- Starting voltage: DC2.5V MAX.
- 额定转速: 变化率在初始值的-30%~+50%以内。
- Rated speed: changing rate must be within -30%~+50% of initial value.
- 额定电流: 变化率在初始值的-30%~+50%以内。
- Rated current: changing rate must be within -30%~+50%of initial value.

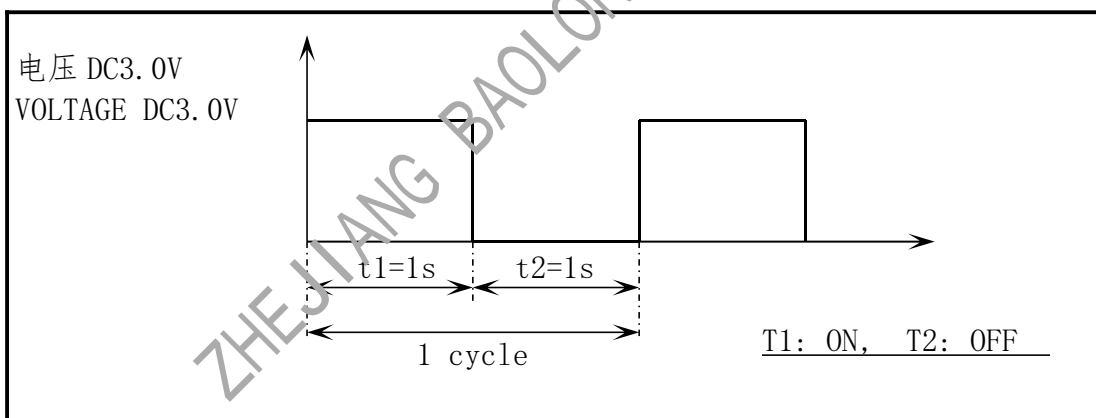

| | |
|---------------------------------------|-------------------|
| 产品规格书/Specifications | 日期/Date :2016-9-8 |
| 振动马达/Vibration motor:BVM0720-FP35-1RU | 页码/Page : 9 / 13 |

8. 注意事项/CAUTION FOR USE

(1) 该马达是微型精密产品，在运输过程中不要承受超过0.5 kgf的力，否则会引起外形或性能的变化。

As this motor is small and precise, do not press it over 0.5kgf force or while transportation, it can cause the transformation of performance or external appearance.

(2) 请注意马达不要接触到液体性物质（比如：水，酒精等）

please be careful, not to be contacted fluid substances (such as: water, alcohol etc.)

(3) 不要在高温下长时间放置，否则有可能导致电机的性能下降。

Do not expose the motor to high temperature for a long periods of time, it may cause a decline in performance.

(4) 马达不要在以下环境中使用：

- 高温和高湿的场所
- 腐蚀性气体如H₂S、SO₂、NO₂等

Avoid using the motor in the following environment.

- High temperature and high humidity area.
- Corrosive gas such as H₂S、SO₂、NO₂ etc.

(5) 请不要在靠近磁铁或带有磁场的仪器旁边使用或存放马达。

Please do not operate or store the motor adjacent to magnet or apparatus That has a magnetic field.

(6) 请注意底盖的表面存在漏磁通量。

Please be careful that there exists a leaking magnetic flux on the surface of bracket.

(7) 电刷和换向器的相互作用，有可能产生轻微的电噪音。

Due to interaction between brush and commutator, there is a possibility to occur electrical noise slightly.

(8) 如有任何问题，宝龙和客户双方应共同努力解决。

If any problems occur, both the user and baolong electron shall try to solve the problem.

(9) 因测试设备有误差，允许有±5%偏差。

Beacause there is error of the measurement equipment ,permit the standard of the rotational frepency to ±5%

(10) 马达通过ROHS认证

This motor pass the system of ROHS certification

9. 附/Attached

9-1 马达特性图/characteristic graph of motor

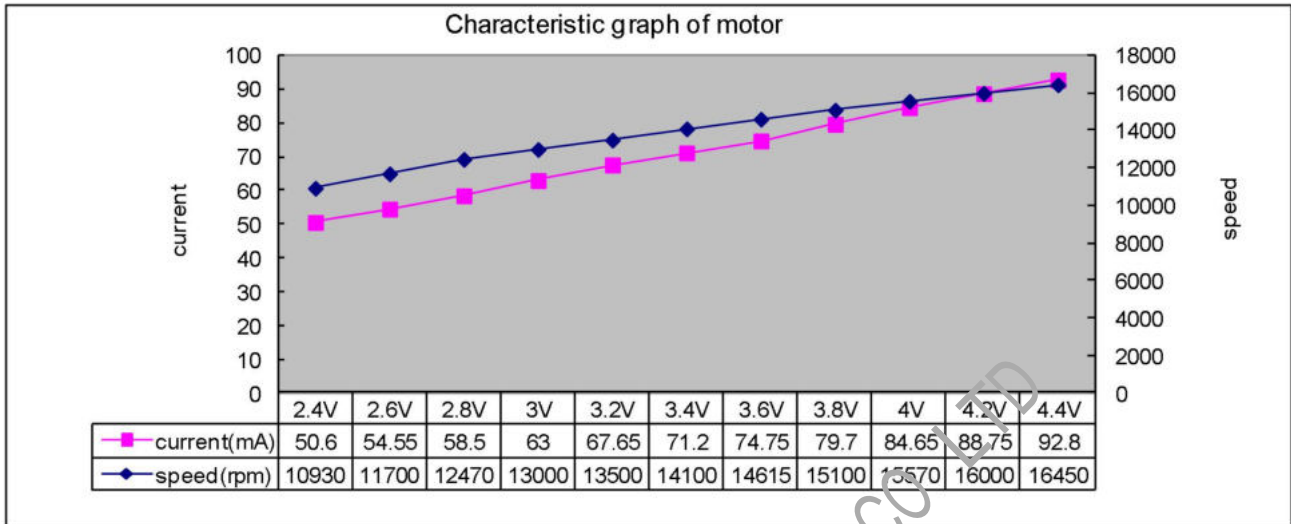

9-2 标准测量方式/state of standard measurement

测试项目：启动电压，额定电压下的电流，额定电压下的转速，绝缘电阻。

Measure item: starting voltage, current at rated voltage, speed at rated voltage, insulation resistance.

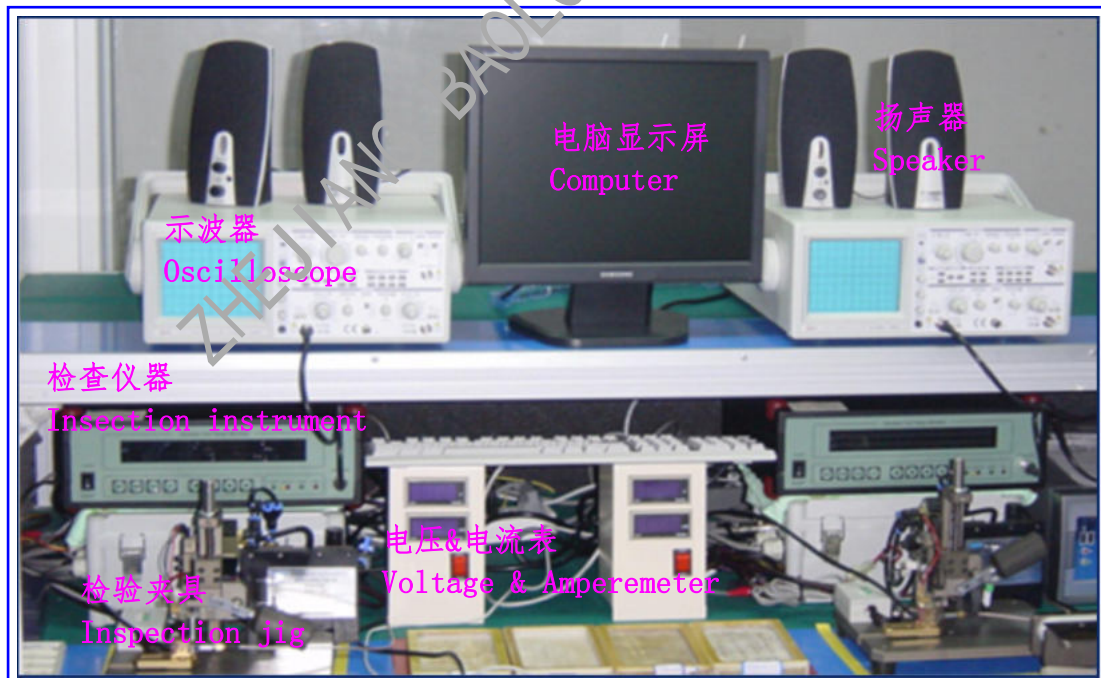

10. 外形图/Outside view

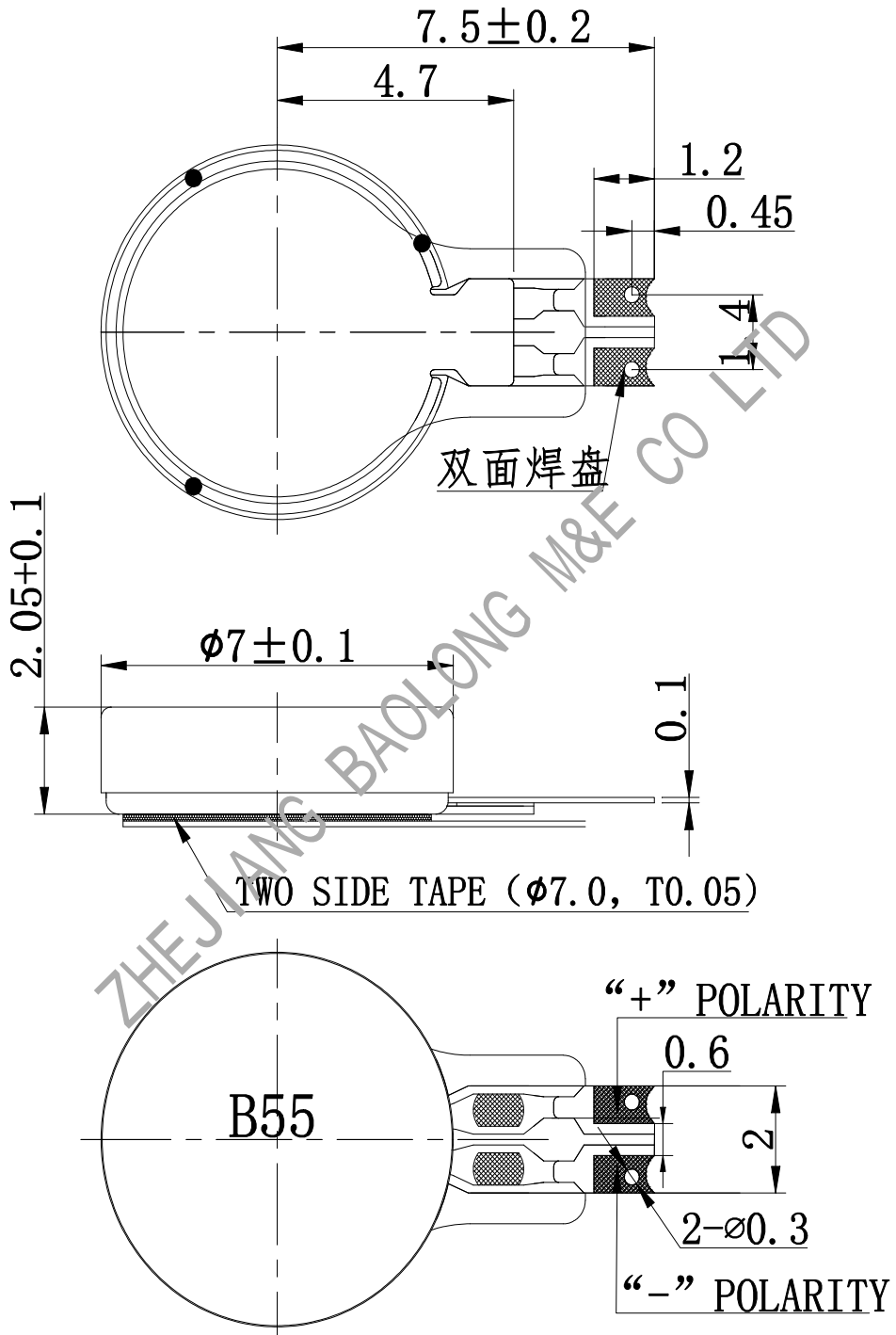

11. 结构图及物料清单/Structure drawing & BOM

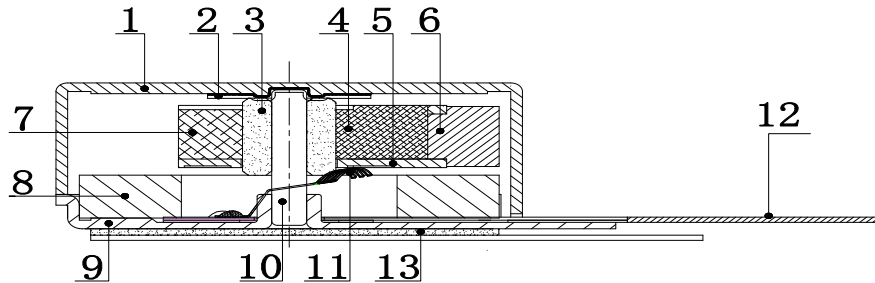

| NO. | 物料名称/Part name | 材料/Material |
|-----|---------------------------|-------------------|
| 1 | 上机壳 Upper case | SPC-E |
| 2 | 滑片 Slide | PE+ACRYLIC |
| 3 | 轴承 Bearing | FCS |
| 4 | 线圈 Coil | Copper+PU |
| 5 | 硬基板 HPCB | EPOXY |
| 6 | 振子 Weight | Tungsten alloy |
| 7 | 塑料 Resin | PBT |
| 8 | 磁钢 Magnet | NdFeB |
| 9 | 下机壳 Lower case | SPC-E |
| 10 | 钢轴 Shaft | DSR7B |
| 11 | 电刷 Brush | MX215 |
| 12 | 软基板 FPCB | PI+AD+Copper+Glue |
| 13 | 双面胶 double-sided adhesive | cloth+adhesive |

12. 包装/Packaging



吸塑盒尺寸(长:222mm 宽:180mm 高:13mm)
Tray dimension (L:222mm W:180mm H:13mm)
每个吸塑盒放 50 只
50 Pcs per tray



内箱尺寸(长:238mm 宽:190mm 高:130mm)
Inner-box dimension (L:238mm W:190mm H:130mm)
每 21 个吸塑盒捆在一起,数量为 1000 只,
装入内箱
Put into inner-box 21 tray together
with tape 1000 Pcs per 21 tray .



4 个内箱装入外箱, 数量共 4000 只;
Put 4 inner-box into outer-box, total
4000 Pcs.
外箱尺寸: (长:405mm 宽:270mm 高:300mm)
Outer-box dimension:
(L:405mm W:270mm H:300mm)